

工业用冷水机组

使用说明书





45

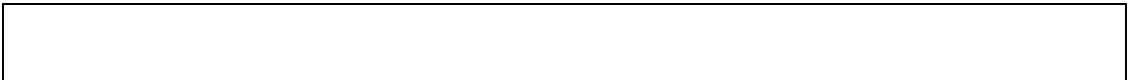

45



严禁水冷却机水箱内带有水或者其他液体进行运输!!!



1



1.0MPa



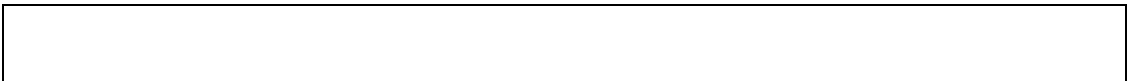

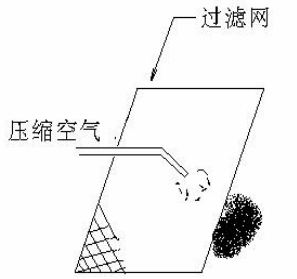

用压缩空气清除灰尘

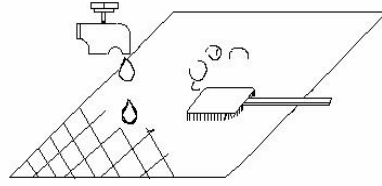

清洗过滤网后使之干燥



--



0 55

90%RH



3000



10



--



!

--

1.

500

2.

1000

3.

30000

1	9
2	9
3	10
4	10
5	11
6	12
7	12
8	13
9	15

1

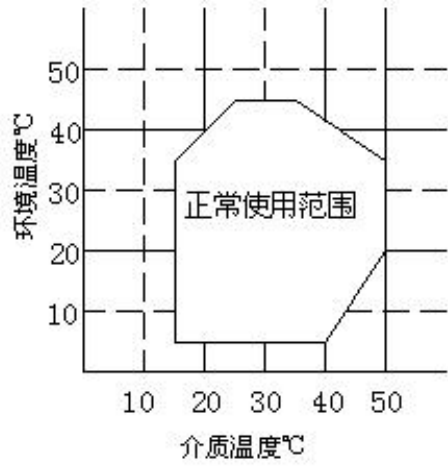

2

JYP-250C

1

JYP:

2

x 100 W

250:

250x 100W = 25000 W

3)

P:

C:

S:

R

4

5

1225 AC 1P 220V/50hz

3385: AC 3P 380V/50hz

338N5 AC 3P+N 380V/50hz ()

3

1

45

2

3

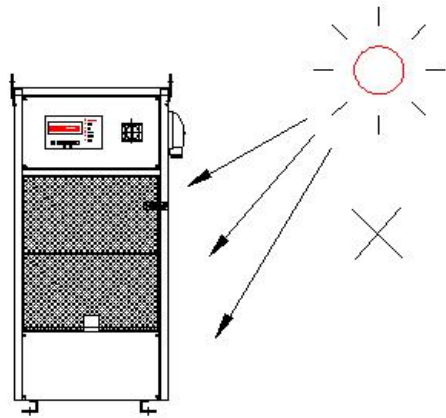
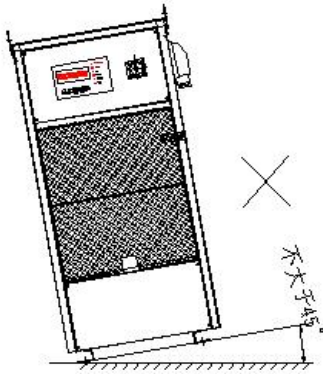

5

4

1

2

3

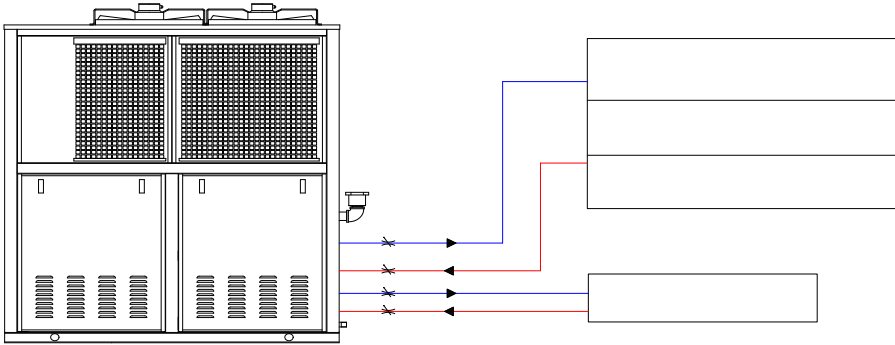

4

5

6

5

1

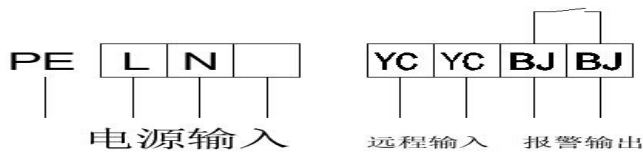
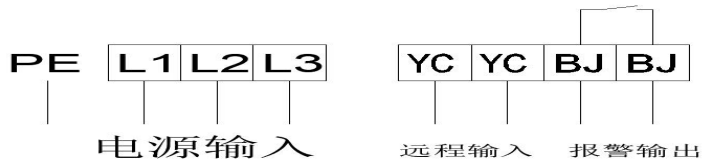
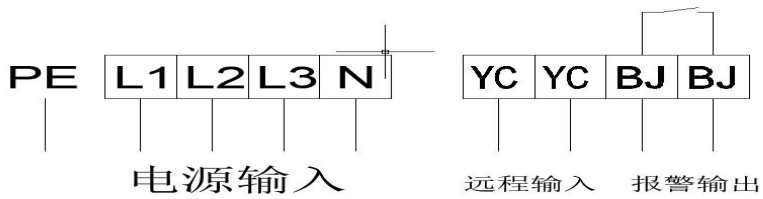

2 L N PE

3

4

	5A	10A	15A	25A	35A	50A
	1.0 ²	1.5 ²	2.5 ²	4 ²	6 ²	10 ²

5

6 10% 1Hz

7

yc

;

6

1

2



a)

b)

7

1

2
3
8

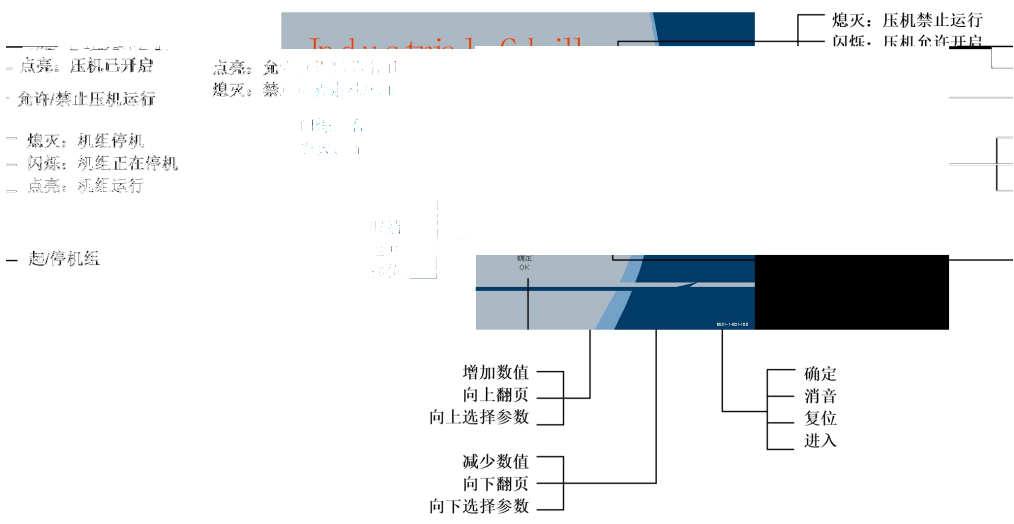

8.1

8.1.1

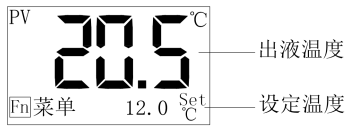

8.1.2



8.2

8.2.1

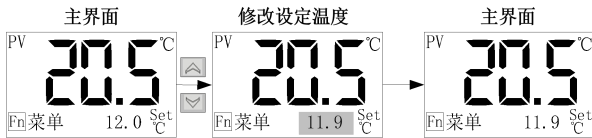

8.2.2

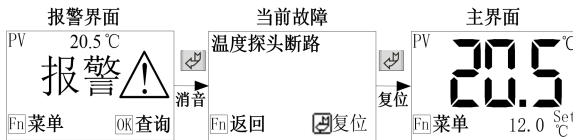

8.2.3



8.3



8.4

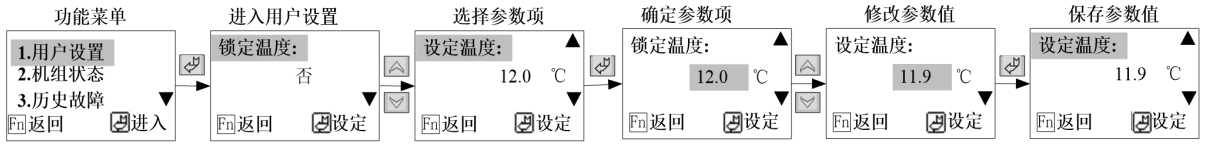

8.5

9.

	<u>JYP-08P</u>
	1-220V 3-380V 3+N-380V
	0512-62995660